

REV.	DESCRIPTION	APPD	DATE

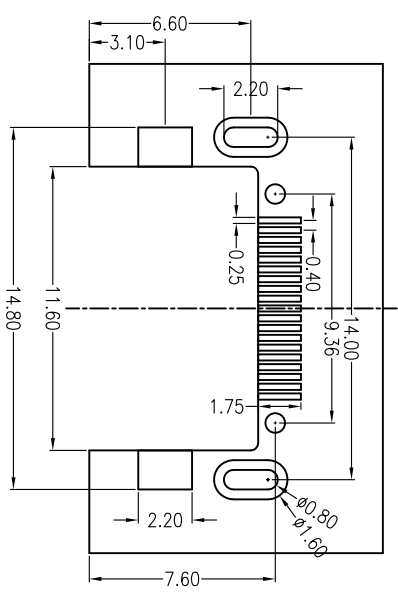
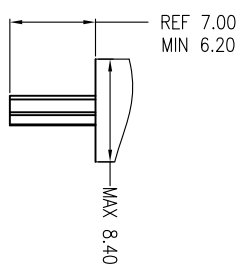
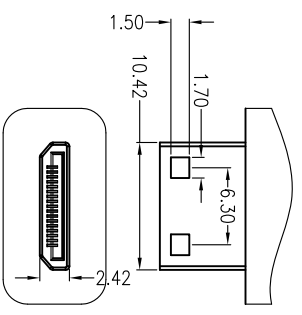
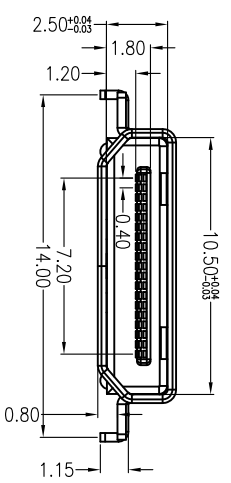
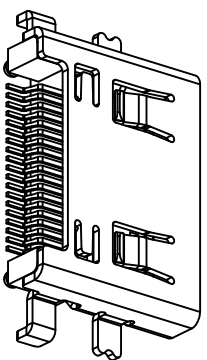
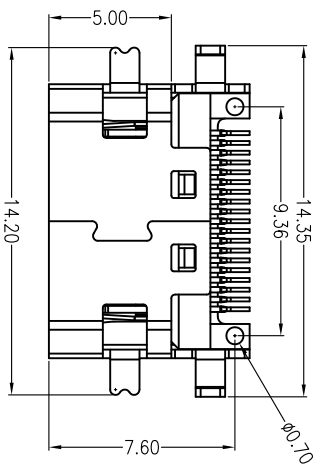
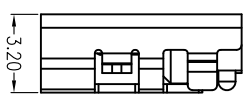
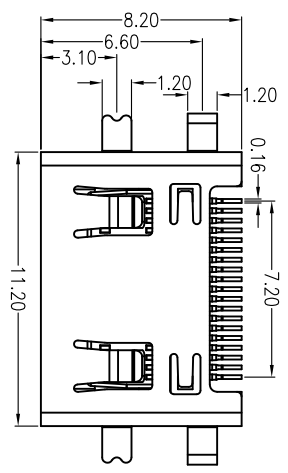
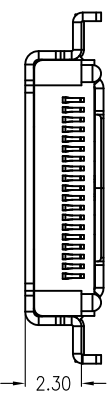

NOTES:

- 1.MATERIAL:  
HOUSING: HIGH TEMPERATURE THERMOPLASTIC  
UL94V\_0,COLOR:BLACK.  
CONTACT: COPPER ALLOYS.  
COVER: COPPER ALLOYS OR STEEL.
- 2.PLATING:  
UNDERPLATE: NICKEL.  
CONTACT AREA: GOLD OVER NICKEL.  
SOLDER AREA: GOLD OVER NICKEL.
- 3.MULTIMEDIA CARD COMPATIBLE

PART NO: HOST-F1P2-2000-A		MATERIAL:	
LOT NO:		FINSH:	
UNIT: MM	SIZE: A4	COLOR:	
TOLERANCES: X.X=±0.35 X.XX=±0.25 X.XXX=±0.15		GENERAL ANGLE: X.X=±3.0° X.XX=±2.0°	
DR: PENTIUM 0408'10		TITLE: MINI HDMI ( C TYPE ) 沉板0.8	
CHK:		DWG NO: FP-100065	
APP:		SCALE: 1 : 1	
		SHEET: 1 OF 1	
		REV: C/0	

东莞市高铨达电子科技有限公司